



D5

PARTS & ACCESSORIES



EVOLUTION ELECTRIC VEHICLES INC

Corporate Offices: 2620 Palisades Dr, Corona CA 92882

Florida Distribution: 7600 Narcoossee Rd, Orlando, FL 32822

Texas Distribution: 4053 Grand Lakes Way, Grand Prairie, TX 75050

Office Phone: 951-268-6689 info@evolutionelectricvehicle.com

www.evolutionelectricvehicle.com



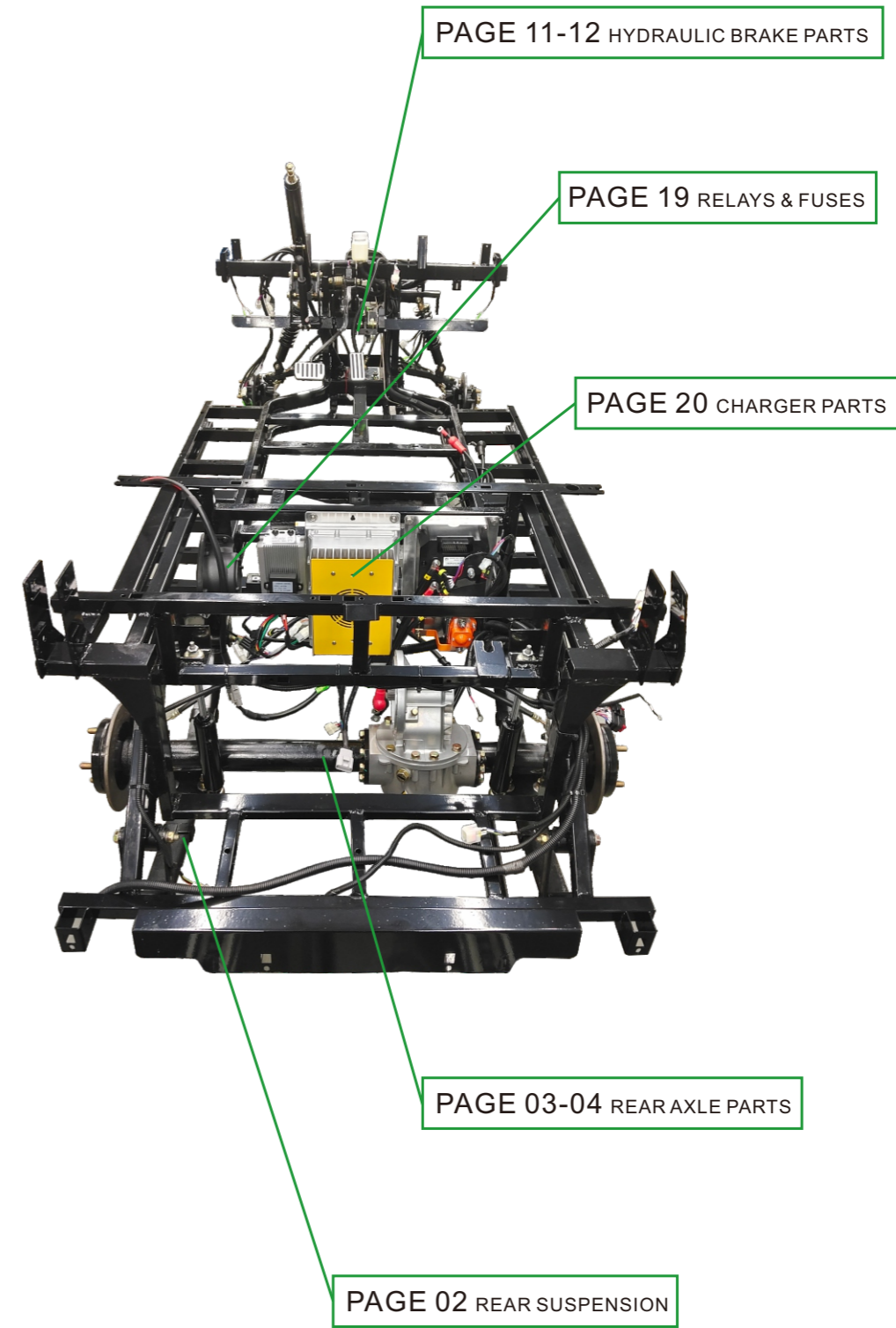
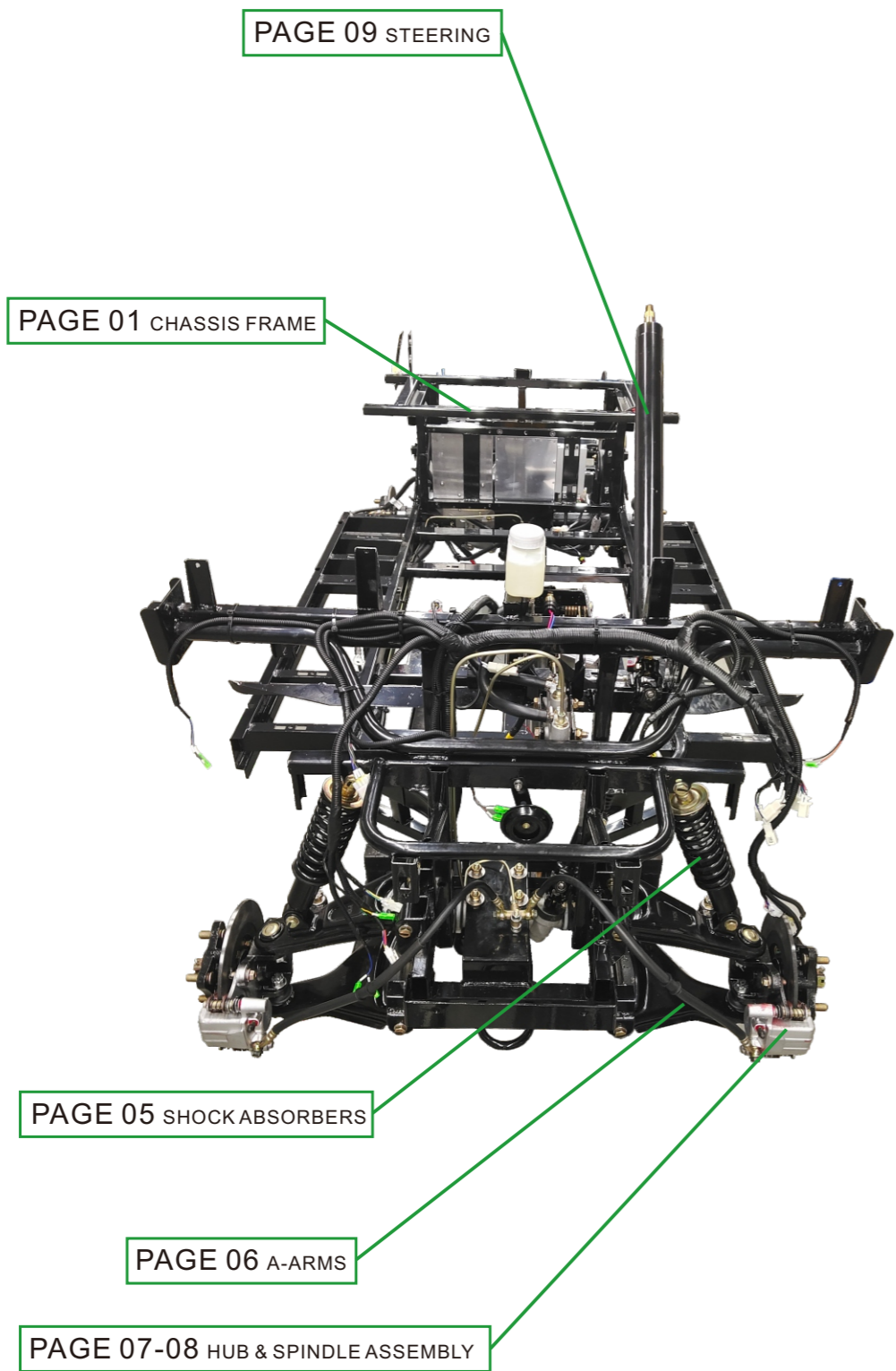



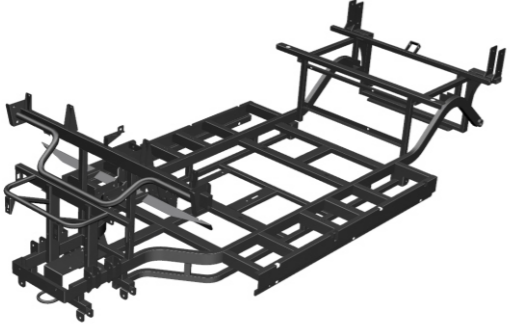

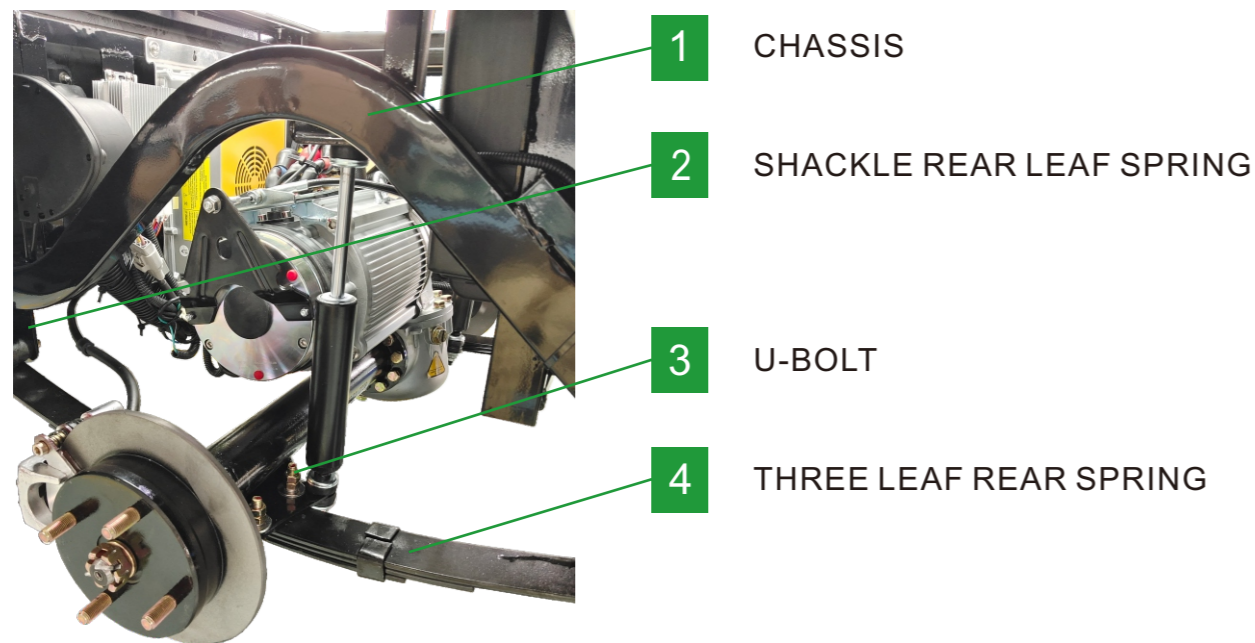
| CHASSIS FRAME | |
|---|--|
| <p>2.01.2224 CHASSIS, DEL3045G APPLY TO LSV4</p>  | <p>2.01.2225 CHASSIS, DEL2045D APPLY TO LSV4 OFF-ROAD</p> |
| <p>2.01.2230 CHASSIS, DEL3065G APPLY TO LSV6</p> | <p>2.01.2360 CHASSIS, DEL2065D APPLY TO LSV6 OFF-ROAD</p> |



| REAR SUSPENSION | |
|---|---|
| <p>2.03.0005 LEAF SPRING BUSHING APPLY TO LSV4 LSV4 OFF-ROAD LSV6 LSV6 OFF-ROAD</p>  | <p>2.03.0006 LEAF SPRING BUSHING SLEEVE APPLY TO LSV4 LSV4 OFF-ROAD LSV6 LSV6 OFF-ROAD</p>  |
| <p>2.01.0024 SHACKLE REAR LEAF SPRING APPLY TO LSV4 LSV4 OFF-ROAD LSV6 LSV6 OFF-ROAD</p>  | <p>2.01.0070 THREE LEAF REAR SPRING APPLY TO LSV4 LSV4 OFF-ROAD</p>  |
| <p>2.01.0927 FOUR LEAF REAR SPRING APPLY TO LSV6 LSV6 OFF-ROAD</p>  | <p>1.08.0007 U-BOLT FOR THREE LEAF REAR SPRING APPLY TO LSV4 LSV4 OFF-ROAD</p>  |
| <p>2.01.0960 U-BOLT FOR FOUR LEAF REAR SPRING APPLY TO LSV6 LSV6 OFF-ROAD</p>  | |

REAR AXLE

2.01.2357

REAR END ASSEMBLY WITH HYDRAULIC DISC BRAKE, Ratio: 12.49:1

APPLY TO
LSV4
LSV4 OFF-ROAD
LSV6
LSV6 OFF-ROAD

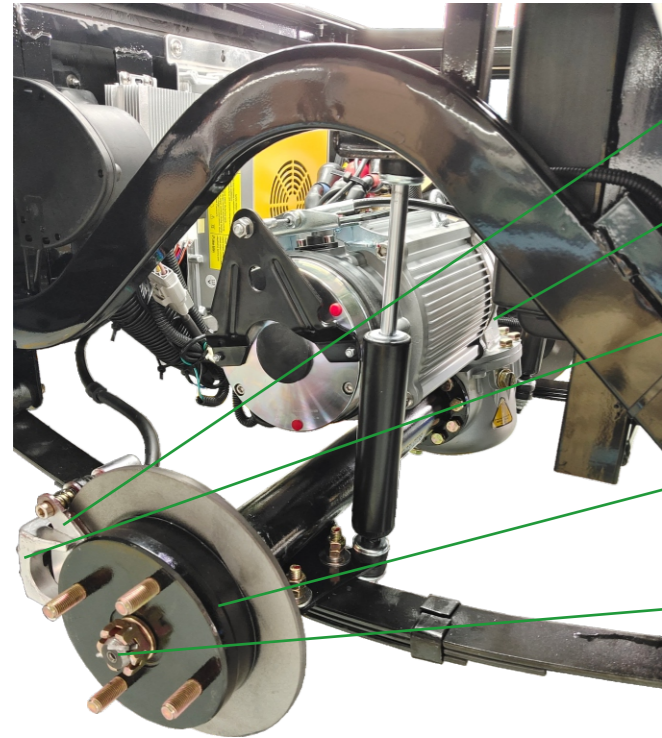

- 1 BRAKE SHOES FOR REAR DISC BRAKE ASSEMBLY
- 2 DIFFERENTIAL ASSEMBLY FOR REAR END
- 3 REAR HYDRAULIC BRAKE CALIPER
- 4 BRAKE DISC
- 5 HALF SHAFT

REAR AXLE PARTS

2.01.2357-3
BRAKE DISC, REAR END ASSEMBLY

4

APPLY TO
LSV4
LSV4 OFF-ROAD
LSV6
LSV6 OFF-ROAD

2.01.2378
REAR HYDRAULIC BRAKE CALIPER, DRIVER SIDE

3

APPLY TO
LSV4
LSV4 OFF-ROAD
LSV6
LSV6 OFF-ROAD

2.01.2379
REAR HYDRAULIC BRAKE CALIPER, PASSENGER SIDE

3

APPLY TO
LSV4
LSV4 OFF-ROAD
LSV6
LSV6 OFF-ROAD

2.01.2381
BRAKE SHOES FOR REAR DISC BRAKE ASSEMBLY

1

APPLY TO
LSV4
LSV4 OFF-ROAD
LSV6
LSV6 OFF-ROAD

2.01.2357-2
HALF SHAFT (SHORT)

6

APPLY TO
LSV4
LSV4 OFF-ROAD
LSV6
LSV6 OFF-ROAD

2.01.2357-1
HALF SHAFT (LONG)

6

APPLY TO
LSV4
LSV4 OFF-ROAD
LSV6
LSV6 OFF-ROAD

1.08.0014
BEARING, REAR END ASSEMBLY

APPLY TO
LSV4
LSV4 OFF-ROAD
LSV6
LSV6 OFF-ROAD



1.08.0063
JUMP RING FOR HALF AXLE

APPLY TO
LSV4
LSV4 OFF-ROAD
LSV6
LSV6 OFF-ROAD

2.01.1405
DIFFERENTIAL ASSEMBLY FOR REAR END



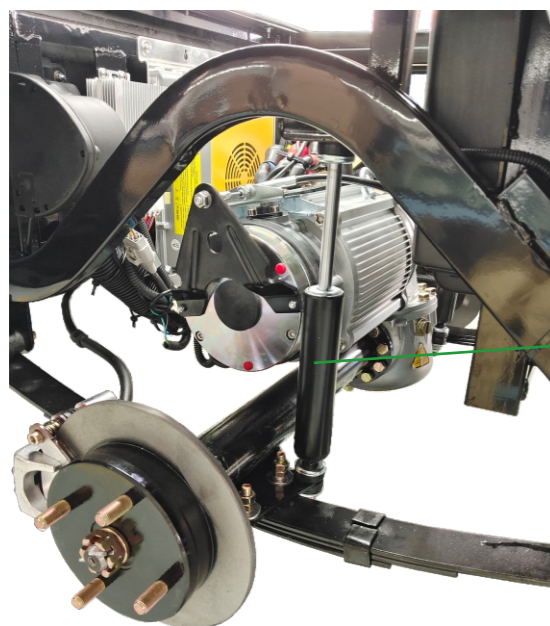

2

APPLY TO
LSV4
LSV4 OFF-ROAD
LSV6
LSV6 OFF-ROAD

| SHOCK ABSORBERS | |
|--|--|
| <p>2.01.0087 FRONT SHOCK ABSORBER</p> <p>APPLY TO LSV4 LSV4 OFF-ROAD LSV6 LSV6 OFF-ROAD</p> |  |
| <p>2.01.0025 REAR SHOCK ABSORBER</p> <p>APPLY TO LSV4 LSV4 OFF-ROAD</p> | <p>1</p>  |
| <p>2.01.0088 REAR SHOCK ABSORBER, LIFTED CART</p> <p>APPLY TO LSV6 LSV6 OFF-ROAD</p> | <p>1</p>  |





1 JOINT COMPOUND STEERING

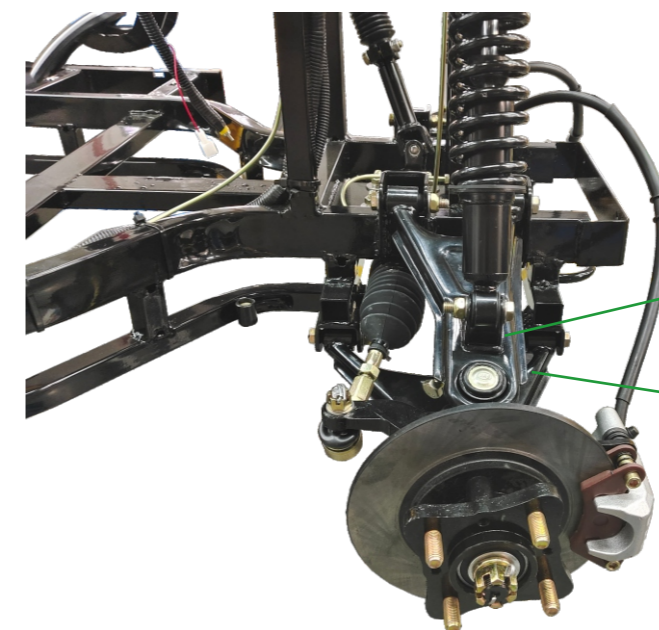

| A-ARMS | |
|---|--|
| <p>2.01.1787 NEW STAMPING A-ARM, UPPER, DRIVER SIDE</p> <p>APPLY TO LSV4 LSV4 OFF-ROAD LSV6 LSV6 OFF-ROAD</p> | <p>2</p>  |
| <p>2.01.1788 NEW STAMPING A-ARM, UPPER, PASSENGER SIDE</p> <p>APPLY TO LSV4 LSV4 OFF-ROAD LSV6 LSV6 OFF-ROAD</p> | <p>2</p>  |
| <p>2.01.1789 NEW STAMPING A-ARM, LOWER, DRIVER SIDE</p> <p>APPLY TO LSV4 LSV4 OFF-ROAD LSV6 LSV6 OFF-ROAD</p> | <p>3</p>  |
| <p>2.01.1790 NEW STAMPING A-ARM, LOWER, PASSENGER SIDE</p> <p>APPLY TO LSV4 LSV4 OFF-ROAD LSV6 LSV6 OFF-ROAD</p> | <p>3</p>  |









2 NEW STAMPING A-ARM, LOWER

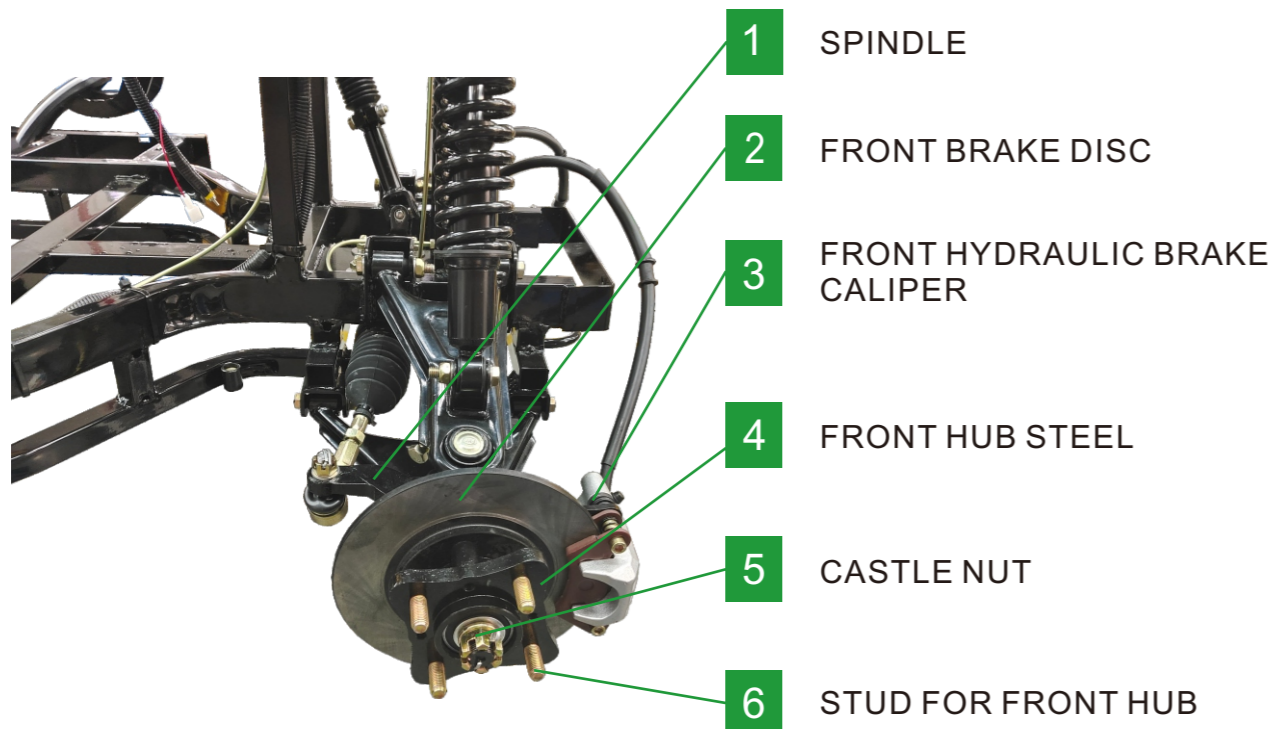



3 NEW STAMPING A-ARM, LOWER

| HUB & SPINDLE ASSEMBLY | |
|--|---|
| <p>2.01.2358 FRONT SPINDLE & DISC BRAKE ASSEMBLY, DRIVER SIDE</p> <p>APPLY TO LSV4 LSV4 OFF-ROAD LSV6 LSV6 OFF-ROAD</p>  | <p>2.01.2359 FRONT SPINDLE & DISC BRAKE ASSEMBLY, PASSENGER SIDE</p> <p>APPLY TO LSV4 LSV4 OFF-ROAD LSV6 LSV6 OFF-ROAD</p>  |

| HUB & SPINDLE ASSEMBLY PARTS | |
|--|---|
| <p>2.01.2358-1 1 SPINDLE, DRIVER SIDE</p> <p>APPLY TO LSV4 LSV4 OFF-ROAD LSV6 LSV6 OFF-ROAD</p>  | <p>2.01.2359-1 1 SPINDLE, PASSENGER SIDE</p> <p>APPLY TO LSV4 LSV4 OFF-ROAD LSV6 LSV6 OFF-ROAD</p>  |



| HUB & SPINDLE ASSEMBLY PARTS | |
|--|---|
| <p>2.01.2129 2 FRONT BRAKE DISC</p> <p>APPLY TO LSV4 LSV4 OFF-ROAD LSV6 LSV6 OFF-ROAD</p> | <p>2.01.1495 4 FRONT HUB STEEL</p> <p>APPLY TO LSV4 LSV4 OFF-ROAD LSV6 LSV6 OFF-ROAD</p>  |
| <p>2.01.2378 3 FRONT HYDRAULIC BRAKE CALIPER, DRIVER SIDE</p> <p>APPLY TO LSV4 LSV4 OFF-ROAD LSV6 LSV6 OFF-ROAD</p> | <p>2.01.2379 3 FRONT HYDRAULIC BRAKE CALIPER, PASSENGER SIDE</p> <p>APPLY TO LSV4 LSV4 OFF-ROAD LSV6 LSV6 OFF-ROAD</p> |
| <p>1.08.0062 COTTER</p> <p>APPLY TO LSV4 LSV4 OFF-ROAD LSV6 LSV6 OFF-ROAD</p>  | <p>1.08.0026 5 CASTLE NUT</p> <p>APPLY TO LSV4 LSV4 OFF-ROAD LSV6 LSV6 OFF-ROAD</p>  |
| <p>1.08.0002 6 STUD FOR FRONT HUB, M12x40</p> <p>APPLY TO LSV4 LSV4 OFF-ROAD LSV6 LSV6 OFF-ROAD</p>  | <p>1.08.0059 FRONT HUB BEARING SET 6205</p> <p>APPLY TO LSV4 LSV4 OFF-ROAD LSV6 LSV6 OFF-ROAD</p>  |
| <p>1.03.0117 COLOR ZINC WASHER</p> <p>APPLY TO LSV4 LSV4 OFF-ROAD LSV6 LSV6 OFF-ROAD</p> | <p>1.08.0059 COLOR ZINC SNAP WASHER</p> <p>APPLY TO LSV4 LSV4 OFF-ROAD LSV6 LSV6 OFF-ROAD</p> |
| <p>2.01.2381 BRAKE SHOES FOR FRONT HYDRAULIC BRAKE</p> <p>APPLY TO LSV4 LSV4 OFF-ROAD LSV6 LSV6 OFF-ROAD</p> | |

| STEERING | |
|--|--|
| <p>2.01.2212 STEERING GEAR BOX ASSEMBLY APPLY TO LSV4 / LSV4 OFF-ROAD / LSV6 / LSV6 OFF-ROAD</p> | <p>4 </p> |
| <p>2.01.2044 STEERING COLUMN APPLY TO LSV4 / LSV4 OFF-ROAD / LSV6 / LSV6 OFF-ROAD</p> | <p>1 </p> |
| <p>2.01.2213 JOINT COMPOUND STEERING APPLY TO LSV4 / LSV4 OFF-ROAD / LSV6 / LSV6 OFF-ROAD</p> | <p>3 </p> |
| <p>2.01.1946 VERTICAL UNLOCKABLE CONTROLLABLE AIR LEVER APPLY TO LSV4 / LSV4 OFF-ROAD / LSV6 / LSV6 OFF-ROAD</p> | <p>2 </p> |
| <p>2.03.2165 ADJUSTABLE FLANGE BRACKET FOR STEERING COLUMN APPLY TO LSV4 / LSV4 OFF-ROAD / LSV6 / LSV6 OFF-ROAD</p> | <p></p> |

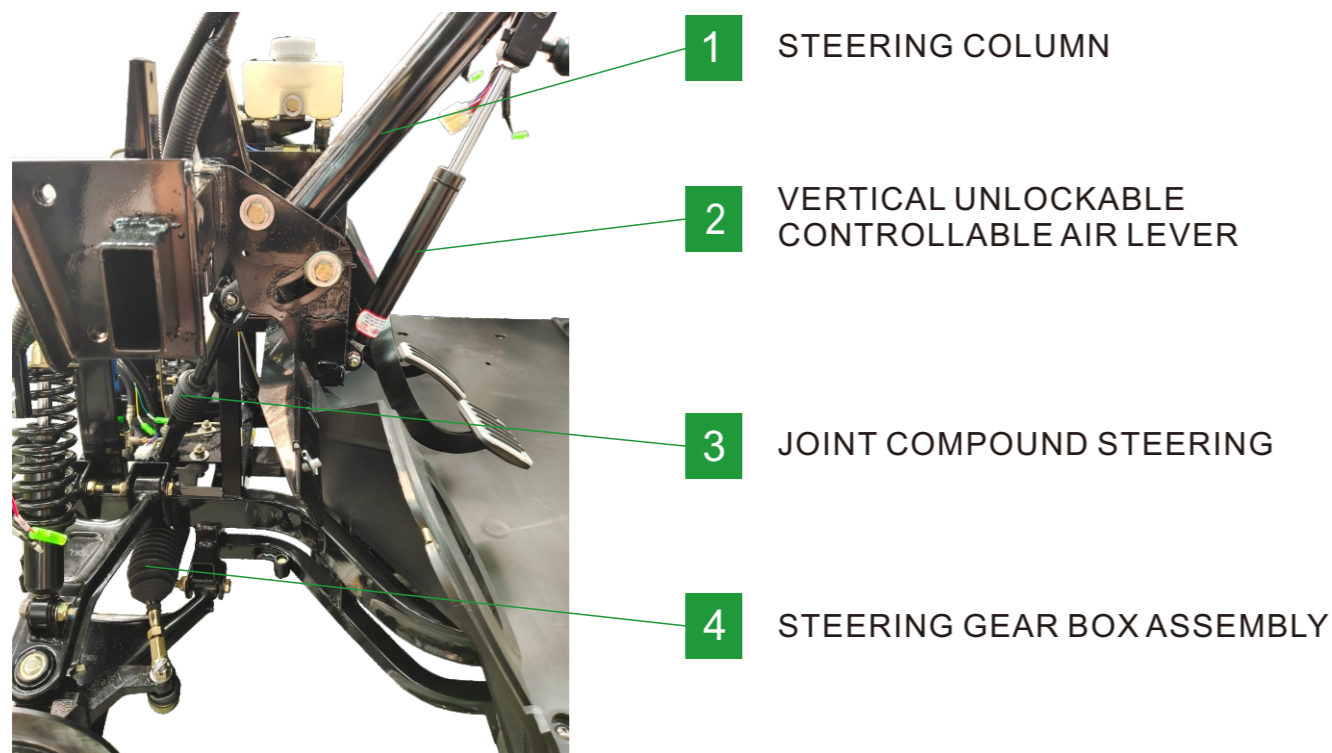

| STEERING GEAR BOX PARTS | |
|---|--|
| <p>1 RUBBER DUST COVER, SMALL OPENING, PASSENGER SIDE APPLY TO LSV4 / LSV4 OFF-ROAD / LSV6 / LSV6 OFF-ROAD</p>  | <p>1 RUBBER DUST COVER, BIG OPENING, DRIVER SIDE APPLY TO LSV4 / LSV4 OFF-ROAD / LSV6 / LSV6 OFF-ROAD</p>  |
| <p>2 JOINT OF TIE ROD FOR STEERING GEAR BOX ASSEMBLY APPLY TO LSV4 / LSV4 OFF-ROAD / LSV6 / LSV6 OFF-ROAD</p>  | <p>3 BULB END FOR STEERING GEAR BOX ASSEMBLY APPLY TO LSV4 / LSV4 OFF-ROAD / LSV6 / LSV6 OFF-ROAD</p>  |

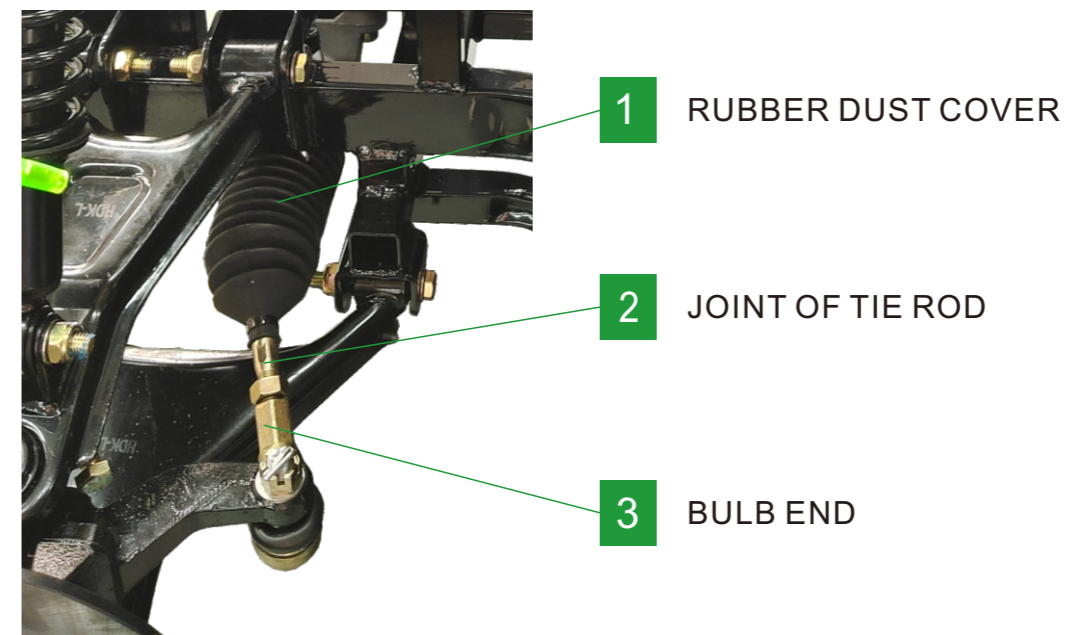





| HYDRAULIC BRAKE PARTS | |
|---|---|
| <p>2.01.1986 BRAKE PEDAL</p> <p>APPLY TO LSV4 LSV4 OFF-ROAD LSV6 LSV6 OFF-ROAD</p>  | <p>2.01.1892 SPRING FOR BRAKE PEDAL, φ5×25×60</p> <p>APPLY TO LSV4 LSV4 OFF-ROAD LSV6 LSV6 OFF-ROAD</p>  |
| <p>2.01.1987 ACCELERATOR PEDAL</p> <p>APPLY TO LSV4 LSV4 OFF-ROAD LSV6 LSV6 OFF-ROAD</p>  | <p>2.01.1916 SPRING FOR ACCELERATOR PEDAL, φ4×16×166</p> <p>APPLY TO LSV4 LSV4 OFF-ROAD LSV6 LSV6 OFF-ROAD</p>  |
| <p>2.01.1915 SLEEVE FOR ACCELERATOR</p> <p>APPLY TO LSV4 LSV4 OFF-ROAD LSV6 LSV6 OFF-ROAD</p>  | <p>2.01.1914 BUSHING FOR ACCELERATOR</p> <p>APPLY TO LSV4 LSV4 OFF-ROAD LSV6 LSV6 OFF-ROAD</p>  |
| <p>2.03.0105 NYLON PAD FOR BRAKE PEDAL BUSHING</p> <p>APPLY TO LSV4 LSV4 OFF-ROAD LSV6 LSV6 OFF-ROAD</p>  | <p>2.01.1917 MOUNTING BASE FOR ACCELERATOR</p> <p>APPLY TO LSV4 LSV4 OFF-ROAD LSV6 LSV6 OFF-ROAD</p>  |
| <p>2.01.0200 THREE DIRECT LINKS, M10×1</p> <p>APPLY TO LSV4 LSV4 OFF-ROAD LSV6 LSV6 OFF-ROAD</p>  | <p>2.01.0201 HYDRAULIC OIL TUBE</p> <p>APPLY TO LSV4 LSV4 OFF-ROAD LSV6 LSV6 OFF-ROAD</p>  |
| <p>2.01.0203 COPPER WASHER WITH SEAL FOR OIL TUBE, 15×10×2</p> <p>APPLY TO LSV4 LSV4 OFF-ROAD LSV6 LSV6 OFF-ROAD</p>  | <p>2.01.0202 BOLT FOR OIL TUBE, M10×1×22</p> <p>APPLY TO LSV4 LSV4 OFF-ROAD LSV6 LSV6 OFF-ROAD</p>  |

| HYDRAULIC BRAKE PARTS | |
|---|--|
| <p>2.01.0537 BOLT FOR OIL TUBE, M10×1.25×22</p> <p>APPLY TO LSV4 LSV4 OFF-ROAD LSV6 LSV6 OFF-ROAD</p>  | <p>2.01.0192 MASTER CYLINDER</p> <p>APPLY TO LSV4 LSV4 OFF-ROAD LSV6 LSV6 OFF-ROAD</p>  |
| <p>2.03.0107 OIL RESERVOIR</p> <p>APPLY TO LSV4 LSV4 OFF-ROAD LSV6 LSV6 OFF-ROAD</p>  | <p>2.03.0108 OIL TUBE, φ10*17</p> <p>APPLY TO LSV4 LSV4 OFF-ROAD LSV6 LSV6 OFF-ROAD</p>  |
| <p>2.01.0213 HOSE CLAMP HYDRAULIC TANK CLAMPS, d=9-16mm</p> <p>APPLY TO LSV4 LSV4 OFF-ROAD LSV6 LSV6 OFF-ROAD</p>  | <p>2.01.0379 BONDI TUBE, L=900MM</p> <p>APPLY TO LSV4 LSV4 OFF-ROAD LSV6 LSV6 OFF-ROAD</p>  |
| <p>2.01.0381 BONDI TUBE, L=2500MM</p> <p>APPLY TO LSV4 LSV4 OFF-ROAD LSV6 LSV6 OFF-ROAD</p>  | <p>2.01.1951 DECORATIVE PAD FOR ACCELERATOR PEDAL</p> <p>APPLY TO LSV4 LSV4 OFF-ROAD LSV6 LSV6 OFF-ROAD</p>  |
| <p>2.01.1952 DECORATIVE PAD FOR BRAKE PEDAL</p> <p>APPLY TO LSV4 LSV4 OFF-ROAD LSV6 LSV6 OFF-ROAD</p>  | <p>2.04.1181 ELECTRIC ACCELERATOR</p> <p>APPLY TO LSV4 LSV4 OFF-ROAD LSV6 LSV6 OFF-ROAD</p>  |

| TIRE | |
|---|--|
| <p>3.04.0181 RADIAL TIRE ASSEMBLY, 225/50R14 APPLY TO LSV4 LSV4 OFF-ROAD</p>  | <p>3.04.0180 OFF-ROAD TIRE ASSEMBLY, 23*10-14 4PR P3118 APPLY TO LSV6 LSV6 OFF-ROAD</p>  |

| WHEEL ACCESSORIES | |
|--|---|
| <p>2.01.2246 WHEEL RIM APPLY TO LSV4 LSV4 OFF-ROAD LSV6 LSV6 OFF-ROAD</p>  | <p>2.03.0656 CENTER DUST CAP APPLY TO LSV4 LSV4 OFF-ROAD LSV6 LSV6 OFF-ROAD</p>  |
| <p>2.03.0056 INFLATING VALVE APPLY TO LSV4 LSV4 OFF-ROAD LSV6 LSV6 OFF-ROAD</p>  | <p>1.08.0017 LUG NUT, M12× 1.25R APPLY TO LSV4 LSV4 OFF-ROAD LSV6 LSV6 OFF-ROAD</p>  |
| <p>2.03.1068 RADIAL TIRE, 225/50R14 APPLY TO LSV4 LSV4 OFF-ROAD</p>  | <p>2.03.1538 OFF-ROAD TIRE, 23*10-14 4PR P3118 APPLY TO LSV6 LSV6 OFF-ROAD</p> |

| WIRE HARNESS | |
|--|--|
| <p>2.04.1362 WIRE HARNESS FOUR SEATER APPLY TO LSV4 LSV4 OFF-ROAD</p>  | |
| <p>2.04.1381 WIRE HARNESS SIX SEATER APPLY TO LSV6 LSV6 OFF-ROAD</p>  | |

| AC MOTOR PARTS | |
|---|--|
| <p>2.04.0917 AC MOTOR WITH MOTOR BRAKE, 48V/6.3KW APPLY TO LSV4 LSV4 OFF-ROAD LSV6 LSV6 OFF-ROAD</p>  | <p>2.04.1257 SPEED ENCODER, AC MOTOR 48V/6.3KW APPLY TO LSV4 LSV4 OFF-ROAD LSV6 LSV6 OFF-ROAD</p>  |

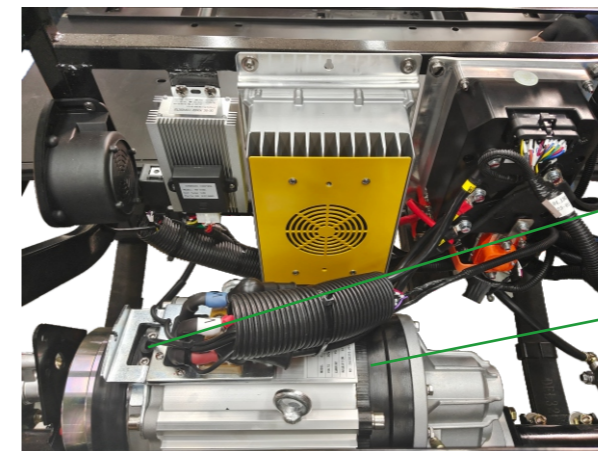

- 1** SPEED ENCODER
- 2** AC MOTOR

CONTROLLER PART







2.04.1182-2 1
 EV48-400-08 EVOLUTION 400A AC
 CONTROLLER
 APPLY TO LSV4 / LSV4 OFF-ROAD / LSV6 / LSV6 OFF-ROAD





DC CONVERTOR

2.04.0024 5
 DC CONVERTOR, 26-60V40A/12V
 APPLY TO LSV4 / LSV4 OFF-ROAD / LSV6 / LSV6 OFF-ROAD







| CONTROLLER CABLE PART | |
|--|--|
| <p>2.01.2366 CONTROLLER MOUNTING BOARD APPLY TO LSV4 LSV4 OFF-ROAD LSV6 LSV6 OFF-ROAD</p>  | <p>2.04.0011 CABLE POLE APPLY TO LSV4 LSV4 OFF-ROAD LSV6 LSV6 OFF-ROAD</p>  |
| <p>2.01.1773 4 FLAT COPPER SHEET(1232SE) APPLY TO LSV4 LSV4 OFF-ROAD LSV6 LSV6 OFF-ROAD</p>  | <p>2.04.0052 MAIN FUSE, 400A APPLY TO LSV4 LSV4 OFF-ROAD LSV6 LSV6 OFF-ROAD</p>  |
| <p>2.04.1363 DATA TRANSFER CABLE APPLY TO LSV4 LSV4 OFF-ROAD LSV6 LSV6 OFF-ROAD</p>  | <p>2.04.1248 2 FLAT COPPER SHEET, 12 APPLY TO LSV4 LSV4 OFF-ROAD LSV6 LSV6 OFF-ROAD</p>  |

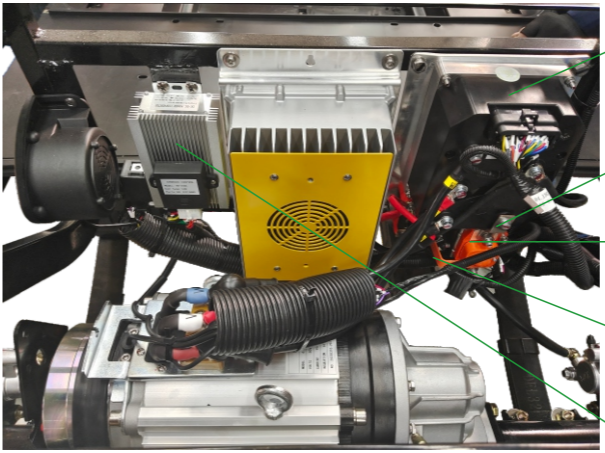



SOLENOID

| | |
|---|---|
| <p>2.04.0009 3 SOLENOID, JQ-200H/48-48AW APPLY TO LSV4 LSV4 OFF-ROAD LSV6 LSV6 OFF-ROAD</p>  | <p>2.01.0035 MOUNTING BRACKET FOR SOLENOID APPLY TO LSV4 LSV4 OFF-ROAD LSV6 LSV6 OFF-ROAD</p>  |
|---|---|

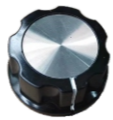

- 1 CONTROLLER
- 2 FLAT COPPER SHEET(1232SE)
- 3 SOLENOID
- 4 FLAT COPPER SHEET, 12
- 5 DC CONVERTOR

| SWITCH | |
|--|---|
| <p>2.04.0036 BRAKE LIGHT SWITCH</p> <p>APPLY TO LSV4 LSV4 OFF-ROAD LSV6 LSV6 OFF-ROAD</p>  | <p>2.04.1298 BLANK KEY FOB</p> <p>APPLY TO LSV4 LSV4 OFF-ROAD LSV6 LSV6 OFF-ROAD</p>  |
| <p>2.04.1365 COMBINATION SWITCH</p> <p>APPLY TO LSV4 LSV4 OFF-ROAD LSV6 LSV6 OFF-ROAD</p>  | <p>2.04.1175 POWER PUSH BUTTON START SYSTEM, 48V</p> <p>APPLY TO LSV4 LSV4 OFF-ROAD LSV6 LSV6 OFF-ROAD</p>  |
| <p>2.03.2328 RUBBER COVER FOR COMBINATION SWITCH</p> <p>APPLY TO LSV4 LSV4 OFF-ROAD LSV6 LSV6 OFF-ROAD</p> | |





| MODE SWITCH | |
|---|---|
| <p>2.04.0916 DIRECTION SHIFTING SWITCH</p> <p>APPLY TO LSV4 / LSV4 OFF-ROAD / LSV6 / LSV6 OFF-ROAD</p>  | |
| <p>2.04.0649 KNOB SWITCH FOR HIGH/LOW SPEED MODE</p> <p>APPLY TO LSV4 LSV4 OFF-ROAD LSV6 LSV6 OFF-ROAD</p>  | <p>2.03.0538 COVER FOR HIGH/LOW SPEED MODE KNOB SWITCH</p> <p>APPLY TO LSV4 LSV4 OFF-ROAD LSV6 LSV6 OFF-ROAD</p>  |
| <p>2.04.1037 STICKER FOR HIGH/LOW SPEED MODE KNOB SWITCH</p> <p>APPLY TO LSV4 LSV4 OFF-ROAD LSV6 LSV6 OFF-ROAD</p>  | |

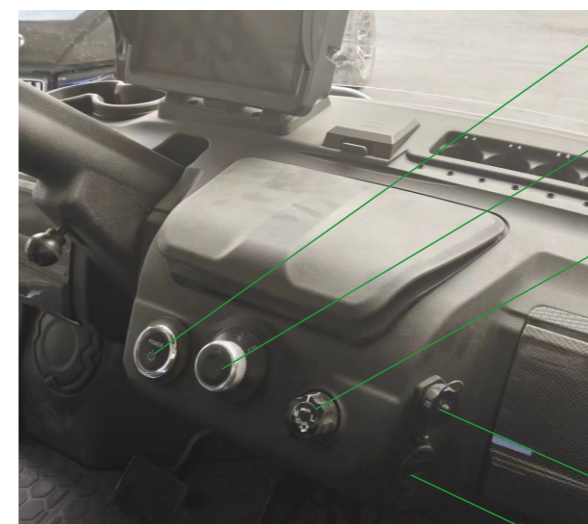

| MULTI-MEDIA | |
|---|---|
| <p>2.04.1088 MICROPHONE</p> <p>APPLY TO LSV4 LSV4 OFF-ROAD LSV6 LSV6 OFF-ROAD</p>  | <p>2.04.1419 12V USB CHARGE PORT</p> <p>APPLY TO LSV4 LSV4 OFF-ROAD LSV6 LSV6 OFF-ROAD</p>  |
| <p>2.04.0891 USB PORT FOR 9 INCH TOUCHSCREEN</p> <p>APPLY TO LSV4 LSV4 OFF-ROAD LSV6 LSV6 OFF-ROAD</p>  | <p>2.04.1366 ANTENNA</p> <p>APPLY TO LSV4 LSV4 OFF-ROAD LSV6 LSV6 OFF-ROAD</p>  |



| HORN | |
|---|--|
| <p>2.04.0006 HORN, 12V</p> <p>APPLY TO LSV4 / LSV4 OFF-ROAD / LSV6 / LSV6 OFF-ROAD</p>  | |







- 1 POWER PUSH BUTTON START SYSTEM
- 2 DIRECTION SHIFTING SWITCH
- 3 KNOB SWITCH FOR HIGH/LOW SPEED MODE
- 4 COVER FOR HIGH/LOW SPEED MODE KNOB SWITCH
- 5 STICKER FOR HIGH/LOW SPEED MODE KNOB SWITCH
- 6 USB PORT FOR TOUCHSCREEN
- 7 USB CHARGE PORT

| TOUCHSCREEN | |
|--|---|
| <p>3.04.0161 TOUCHSCREEN, 9INCH, 12V APPLY TO LSV4 LSV4 OFF-ROAD LSV6 LSV6 OFF-ROAD</p>  | <p>2.04.1073 BACK UP CAMERA APPLY TO LSV4 LSV4 OFF-ROAD LSV6 LSV6 OFF-ROAD</p>  |
| <p>2.04.1077 DOUBLE SHIELDED WIRE APPLY TO LSV4 LSV4 OFF-ROAD LSV6 LSV6 OFF-ROAD</p>  | <p>2.07.0291 BELLOW APPLY TO LSV4 LSV4 OFF-ROAD LSV6 LSV6 OFF-ROAD</p>  |

| SPEAKER | |
|---|--|
| <p>3.04.0162 SOUND BAR APPLY TO LSV4 / LSV4 OFF-ROAD / LSV6 / LSV6 OFF-ROAD</p>  | |
| <p>2.04.1447 ADAPTER CABLE FOR SOUND BAR APPLY TO LSV4 / LSV4 OFF-ROAD / LSV6 / LSV6 OFF-ROAD</p>  | |
| <p>2.01.2339 MOUNTING BRACKET FOR SOUND BAR APPLY TO LSV4 / LSV4 OFF-ROAD / LSV6 / LSV6 OFF-ROAD</p>  | |

| RELAYS & FUSES | |
|--|---|
| <p>2.04.0027 FLASHER, 100W APPLY TO LSV4 LSV4 OFF-ROAD LSV6 LSV6 OFF-ROAD</p>  | <p>2.04.1155 PEDESTRIAN ALERT SOUND GENERATOR 1 APPLY TO LSV4 LSV4 OFF-ROAD LSV6 LSV6 OFF-ROAD</p>  |



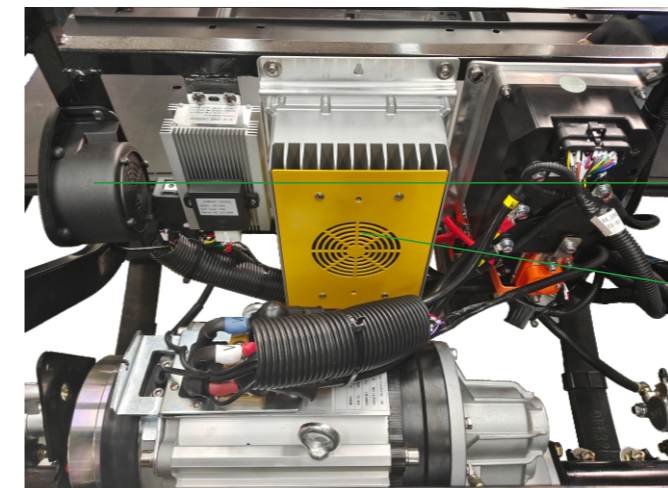







| CHARGER PARTS | |
|---|---|
| <p>2.04.0901 2 LITHIUM BATTERY CHARGER, COMMON USED ON LITHIUM BATTERY & TROJAN BATTERY, 110V 48V/25A APPLY TO LSV4 / LSV4 OFF-ROAD / LSV6 / LSV6 OFF-ROAD</p>  | |
| <p>2.04.0620 CHARGING CORD ASSEMBLY (UL-STANDARD) APPLY TO LSV4 LSV4 OFF-ROAD LSV6 LSV6 OFF-ROAD</p>  | <p>2.04.0602 CHARGE RECEPTACLE WITH CABLE APPLY TO LSV4 LSV4 OFF-ROAD LSV6 LSV6 OFF-ROAD</p>  |
| <p>2.04.0468 CHARGER INDICATOR APPLY TO LSV4 LSV4 OFF-ROAD LSV6 LSV6 OFF-ROAD</p>  | |







- 1 PEDESTRIAN ALERT SOUND GENERATOR
- 2 LITHIUM BATTERY CHARGER

| LIGHT PARTS | |
|---|--|
| <p>2.04.1368 HEADLIGHT, DRIVER SIDE</p> <p>APPLY TO LSV4 LSV4 OFF-ROAD LSV6 LSV6 OFF-ROAD</p>  | <p>2.04.1369 HEADLIGHT, PASSENGER SIDE</p> <p>APPLY TO LSV4 LSV4 OFF-ROAD LSV6 LSV6 OFF-ROAD</p>  |
| <p>2.04.1370 TAILLIGHT, DRIVER SIDE</p> <p>APPLY TO LSV4 LSV4 OFF-ROAD LSV6 LSV6 OFF-ROAD</p>  | <p>2.04.1371 TAILLIGHT, PASSENGER SIDE</p> <p>APPLY TO LSV4 LSV4 OFF-ROAD LSV6 LSV6 OFF-ROAD</p>  |
| <p>2.03.1539 REARVIEW MIRROR, DRIVER SIDE</p> <p>APPLY TO LSV4 LSV4 OFF-ROAD LSV6 LSV6 OFF-ROAD</p>  | <p>2.03.1540 REARVIEW MIRROR, PASSENGER SIDE</p> <p>APPLY TO LSV4 LSV4 OFF-ROAD LSV6 LSV6 OFF-ROAD</p>  |
| <p>2.04.1414 LICENSE LIGHT</p> <p>APPLY TO LSV4 LSV4 OFF-ROAD LSV6 LSV6 OFF-ROAD</p>  | <p>2.04.1461 CONNECTION CABLE FOR REARVIEW MIRROR</p> <p>APPLY TO LSV4 LSV4 OFF-ROAD LSV6 LSV6 OFF-ROAD</p>  |

| REARVIEW MIRROR PARTS | |
|--|---|
| <p>MOUNTING BRACKET FOR REARVIEW MIRROR, DRIVER SIDE</p> <p>APPLY TO LSV4 LSV4 OFF-ROAD LSV6 LSV6 OFF-ROAD</p> | <p>MOUNTING BRACKET FOR REARVIEW MIRROR, PASSENGER SIDE</p> <p>APPLY TO LSV4 LSV4 OFF-ROAD LSV6 LSV6 OFF-ROAD</p> |

| BASE BOARD PARTS | |
|---|--|
| <p>2.03.1568 REAR BASE PLATE</p> <p>APPLY TO LSV4 LSV4 OFF-ROAD LSV6 LSV6 OFF-ROAD</p>  | <p>2.03.1567 FRONT BASE PLATE</p> <p>APPLY TO LSV4 LSV4 OFF-ROAD LSV6 LSV6 OFF-ROAD</p>  |
| <p>2.03.2134 MEDIUM BASE PLATE</p> <p>APPLY TO LSV6 LSV6 OFF-ROAD</p>  | <p>2.03.1566 REAR BAFFLE FOR FRONT SEAT BUCKET</p> <p>APPLY TO LSV4 LSV4 OFF-ROAD LSV6 LSV6 OFF-ROAD</p>  |
| <p>2.03.1569 BATTERY BOX</p> <p>APPLY TO LSV4 LSV4 OFF-ROAD LSV6 LSV6 OFF-ROAD</p>  | <p>2.01.2071 MEDIUM BARREL FRAME</p> <p>APPLY TO LSV4 LSV4 OFF-ROAD LSV6 LSV6 OFF-ROAD</p>  |
| <p>2.03.1598 REAR FOOTREST RUBBER SKIN</p> <p>APPLY TO LSV4 LSV4 OFF-ROAD LSV6 LSV6 OFF-ROAD</p>  | <p>2.03.1597 FRONT FOOTREST RUBBER SKIN</p> <p>APPLY TO LSV4 LSV4 OFF-ROAD LSV6 LSV6 OFF-ROAD</p>  |
| <p>2.03.1570 FRONT SIDE PANEL, DRIVER SIDE</p> <p>APPLY TO LSV4 LSV4 OFF-ROAD LSV6 LSV6 OFF-ROAD</p>  | <p>2.03.1571 FRONT SIDE PANEL, PASSENGER SIDE</p> <p>APPLY TO LSV4 LSV4 OFF-ROAD LSV6 LSV6 OFF-ROAD</p>  |

| BASE BOARD PARTS | |
|--|---|
| <p>2.03.2135 MEDIUM SIDE PANEL, DRIVER SIDE</p> <p>APPLY TO LSV6 LSV6 OFF-ROAD</p>  | <p>2.03.2136 MEDIUM SIDE PANEL, PASSENGER SIDE</p> <p>APPLY TO LSV6 LSV6 OFF-ROAD</p>  |
| <p>2.03.1572 REAR SIDE PANEL, DRIVER SIDE</p> <p>APPLY TO LSV4 LSV4 OFF-ROAD LSV6 LSV6 OFF-ROAD</p>  | <p>2.03.1573 REAR SIDE PANEL, PASSENGER SIDE</p> <p>APPLY TO LSV4 LSV4 OFF-ROAD LSV6 LSV6 OFF-ROAD</p>  |

BASE BOARD PART

FRONT BAFFLE FOR FRONT SEAT BUCKET 5





APPLY TO LSV4 / LSV4 OFF-ROAD / LSV6 / LSV6 OFF-ROAD











| | |
|--|---|
| <p> 2.03.1565-1 BLACK SAPPHIRE</p> <p> 2.03.1565-2 MINERAL WHITE</p> <p> 2.03.1565-3 ARCTIC GRAY</p> | <p> 2.03.1565-5 FLAMENCO RED</p> <p> 2.03.1565-6 MEDITERRANEAN BLUE</p> <p> 2.03.1565-4 PORTIMAO BLUE</p> |
|--|---|

| DASHBOARD PART | |
|--|--|
| <p>2.03.1549 DASH PANEL</p> <p>APPLY TO LSV4 LSV4 OFF-ROAD LSV6 LSV6 OFF-ROAD</p>  | <p>2.03.1548 CUP HOLDER FOR DASH PANEL</p> <p>APPLY TO LSV4 LSV4 OFF-ROAD LSV6 LSV6 OFF-ROAD</p>  |
| <p>2.03.1558 STORAGE BOX FOR DASH PANEL</p> <p>APPLY TO LSV4 LSV4 OFF-ROAD LSV6 LSV6 OFF-ROAD</p>  | <p>2.03.1557 STORAGE BOX COVER FOR DASH PANEL</p> <p>APPLY TO LSV4 LSV4 OFF-ROAD LSV6 LSV6 OFF-ROAD</p>  |
| <p>2.03.1108 STORAGE BOX COVER LOCK FOR DASH PANEL</p> <p>APPLY TO LSV4 LSV4 OFF-ROAD LSV6 LSV6 OFF-ROAD</p>  | <p>2.03.1139 RUBBER STRIP FOR DASH PANEL</p> <p>APPLY TO LSV4 LSV4 OFF-ROAD LSV6 LSV6 OFF-ROAD</p>  |
| <p>2.03.1563 GLOVE BOX, DRIVER SIDE</p> <p>APPLY TO LSV4 LSV4 OFF-ROAD LSV6 LSV6 OFF-ROAD</p>  | <p>2.03.1564 GLOVE BOX, PASSENGER SIDE</p> <p>APPLY TO LSV4 LSV4 OFF-ROAD LSV6 LSV6 OFF-ROAD</p>  |
| <p>2.03.1561 LEFT DECORATE STRIP FOR GLOVE BOX</p> <p>APPLY TO LSV4 LSV4 OFF-ROAD LSV6 LSV6 OFF-ROAD</p>  | <p>2.03.1562 RIGHT DECORATE STRIP FOR GLOVE BOX</p> <p>APPLY TO LSV4 LSV4 OFF-ROAD LSV6 LSV6 OFF-ROAD</p>  |

| DASHBOARD PARTS | |
|---|--|
| <p>2.03.1559 DOOR FOR GLOVE BOX, DRIVER SIDE</p> <p>APPLY TO LSV4 LSV4 OFF-ROAD LSV6 LSV6 OFF-ROAD</p>  | <p>2.03.1560 DOOR FOR GLOVE BOX, PASSENGER SIDE</p> <p>APPLY TO LSV4 LSV4 OFF-ROAD LSV6 LSV6 OFF-ROAD</p>  |
| <p>2.03.1615 LEFT HINGE FOR GLOVE BOX</p> <p>APPLY TO LSV4 LSV4 OFF-ROAD LSV6 LSV6 OFF-ROAD</p>  | <p>2.03.1616 RIGHT HINGE FOR GLOVE BOX</p> <p>APPLY TO LSV4 LSV4 OFF-ROAD LSV6 LSV6 OFF-ROAD</p>  |
| <p>2.01.0066 LOCK FOR GLOVE BOX</p> <p>APPLY TO LSV4 LSV4 OFF-ROAD LSV6 LSV6 OFF-ROAD</p>  | <p>2.03.1550 BRAKE PEDAL COVER</p> <p>APPLY TO LSV4 LSV4 OFF-ROAD LSV6 LSV6 OFF-ROAD</p>  |
| <p>2.03.1556 BRAKE OIL POT COVER</p> <p>APPLY TO LSV4 LSV4 OFF-ROAD LSV6 LSV6 OFF-ROAD</p>  | <p>2.03.1555 BASE MOUNTING FOR 9 INCH TOUCHSCREEN</p> <p>APPLY TO LSV4 LSV4 OFF-ROAD LSV6 LSV6 OFF-ROAD</p>  |
| <p>2.03.0802 REAR COVER FOR 9 INCH TOUCHSCREEN</p> <p>APPLY TO LSV4 LSV4 OFF-ROAD LSV6 LSV6 OFF-ROAD</p>  | <p>2.03.0801 FRONT COVER FOR 9 INCH TOUCHSCREEN</p> <p>APPLY TO LSV4 LSV4 OFF-ROAD LSV6 LSV6 OFF-ROAD</p>  |
| <p>2.03.0800 SUNSHADE COVER</p> <p>APPLY TO LSV4 LSV4 OFF-ROAD LSV6 LSV6 OFF-ROAD</p>  | <p>2.03.0799 BALL HOLDER</p> <p>APPLY TO LSV4 LSV4 OFF-ROAD LSV6 LSV6 OFF-ROAD</p>  |

| STEERING WHEEL | |
|--|---|
| <p>2.03.1168 STEERING WHEEL ASSEMBLY</p> <p>APPLY TO LSV4 LSV4 OFF-ROAD LSV6 LSV6 OFF-ROAD</p>  | <p>2.03.1552 STEERING COLUMN COVER</p> <p>APPLY TO LSV4 LSV4 OFF-ROAD LSV6 LSV6 OFF-ROAD</p>  |
| <p>2.03.1286 MOUNTING BRACKET FOR MICROPHONE</p> <p>APPLY TO LSV4 LSV4 OFF-ROAD LSV6 LSV6 OFF-ROAD</p>  | <p>2.03.1554 COMBINATION SWITCH COVER, LOWER</p> <p>APPLY TO LSV4 LSV4 OFF-ROAD LSV6 LSV6 OFF-ROAD</p>  |
| <p>2.03.1553 COMBINATION SWITCH COVER, UPPER</p> <p>APPLY TO LSV4 LSV4 OFF-ROAD LSV6 LSV6 OFF-ROAD</p>  | |

| STEERING WHEEL PARTS | |
|--|---|
| <p>2.03.1168-1 STEERING WHEEL</p> <p>APPLY TO LSV4 LSV4 OFF-ROAD LSV6 LSV6 OFF-ROAD</p>  | <p>2.03.1168-3 DECORATIVE STRIP FOR STEERING WHEEL</p>  |
| <p>2.03.1168-2 HORN CONTROLLER FOR STEERING WHEEL</p> <p>APPLY TO LSV4 LSV4 OFF-ROAD LSV6 LSV6 OFF-ROAD</p>  | <p>2.07.0024 LOGO STICKER FOR STEERING WHEEL</p> <p>APPLY TO LSV4 LSV4 OFF-ROAD LSV6 LSV6 OFF-ROAD</p>  |

| WHEEL INNER PANEL PARTS | |
|---|--|
| <p>2.03.1546 FRONT WHEEL INNER PANEL, DRIVER SIDE</p> <p>APPLY TO LSV4 LSV4 OFF-ROAD LSV6 LSV6 OFF-ROAD</p>  | <p>2.03.1586 REAR WHEEL INNER PANEL, DRIVER SIDE</p> <p>APPLY TO LSV4 LSV4 OFF-ROAD LSV6 LSV6 OFF-ROAD</p>  |
| <p>2.03.1547 FRONT WHEEL INNER PANEL, PASSENGER SIDE</p> <p>APPLY TO LSV4 LSV4 OFF-ROAD LSV6 LSV6 OFF-ROAD</p>  | <p>2.03.1587 REAR WHEEL INNER PANEL, PASSENGER SIDE</p> <p>APPLY TO LSV4 LSV4 OFF-ROAD LSV6 LSV6 OFF-ROAD</p>  |

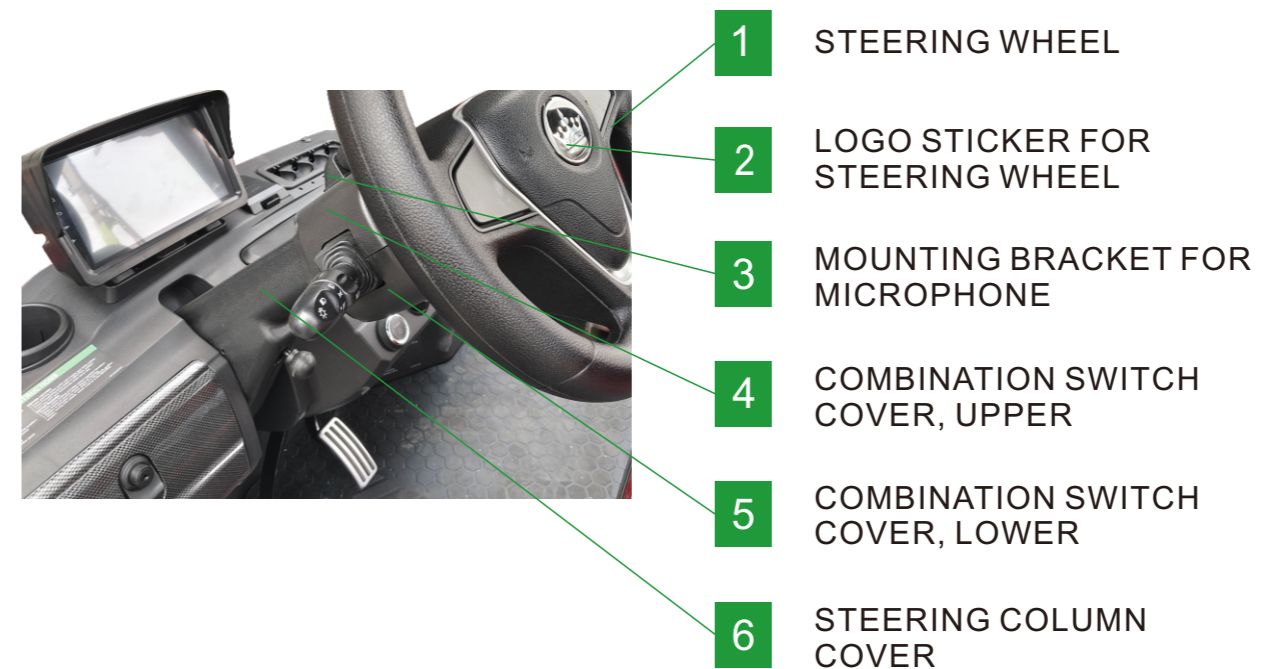

FRONT COWL PARTS

FRONT COWL, D5

APPLY TO LSV4 / LSV4 OFF-ROAD / LSV6 / LSV6 OFF-ROAD

1



2.03.1541-1
BLACK SAPPHIRE

2.03.1541-5
FLAMENCO RED

2.03.1541-2
MINERAL WHITE

2.03.1541-6
MEDITERRANEAN BLUE

2.03.1541-3
ARCTIC GRAY

2.03.1541-4
PORTIMAO BLUE

2.03.1542
CENTER MOULDING COVER

3

APPLY TO
LSV4
LSV4 OFF-ROAD
LSV6
LSV6 OFF-ROAD



2.07.0013
EVOLUTION TRADEMARK PLATE

2

APPLY TO
LSV4
LSV4 OFF-ROAD
LSV6
LSV6 OFF-ROAD



1 FRONT COWL

2 EVOLUTION TRADEMARK PLATE

3 CENTER MOULDING COVER

REAR BODY PARTS

FRONT Baffle FOR REAR COWL, D5

APPLY TO LSV4 / LSV4 OFF-ROAD / LSV6 / LSV6 OFF-ROAD



2.03.1574-1
BLACK SAPPHIRE

2.03.1574-5
FLAMENCO RED

2.03.1574-2
MINERAL WHITE

2.03.1574-6
MEDITERRANEAN BLUE

2.03.1574-3
ARCTIC GRAY

2.03.1574-4
PORTIMAO BLUE

REAR COWL, D5

APPLY TO LSV4 / LSV4 OFF-ROAD / LSV6 / LSV6 OFF-ROAD



2.03.1575-1
BLACK SAPPHIRE

2.03.1575-5
FLAMENCO RED

2.03.1575-2
MINERAL WHITE

2.03.1575-6
MEDITERRANEAN BLUE

2.03.1575-3
ARCTIC GRAY

2.03.1575-4
PORTIMAO BLUE

2.03.2283
SPEAKER DECORATION COVER

APPLY TO
LSV4
LSV4 OFF-ROAD
LSV6
LSV6 OFF-ROAD

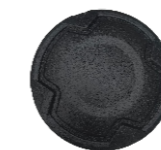

2.03.1588
REAR BUMPER





APPLY TO
LSV4
LSV4 OFF-ROAD
LSV6
LSV6 OFF-ROAD





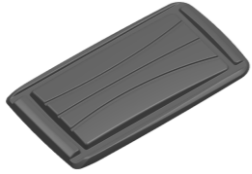





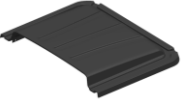

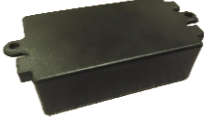

| REAR BODY PARTS | |
|---|---|
| <p>2.03.1579 PROTECTIVE LINING</p> <p>APPLY TO LSV4 LSV4 OFF-ROAD LSV6 LSV6 OFF-ROAD</p>  | <p>2.03.2133 BOTTOM PROTECTIVE BRACKET</p> <p>APPLY TO LSV4 LSV4 OFF-ROAD LSV6 LSV6 OFF-ROAD</p>  |
| <p>2.03.1578 STORAGE BOX FOR REAR SEAT</p> <p>APPLY TO LSV4 LSV4 OFF-ROAD LSV6 LSV6 OFF-ROAD</p>  | <p>2.03.1576 REAR COVER FOR TAILLIGHT, DRIVER SIDE</p>  |
| <p>2.03.1577 REAR COVER FOR TAILLIGHT, PASSENGER SIDE</p> <p>APPLY TO LSV4 LSV4 OFF-ROAD LSV6 LSV6 OFF-ROAD</p>  | <p>2.01.2171 RAILING FOR REAR STORAGE BOX</p> <p>APPLY TO LSV4 LSV4 OFF-ROAD LSV6 LSV6 OFF-ROAD</p>  |
| <p>2.03.2285 RAILING RUBBER FOR REAR STORAGE BOX</p> <p>APPLY TO LSV4 LSV4 OFF-ROAD LSV6 LSV6 OFF-ROAD</p>  | |



| STORAGE BOX PARTS | |
|--|--|
| <p>2.03.2270 BOTTOM BOX FOR REAR STORAGE BOX</p> <p>APPLY TO LSV4 LSV4 OFF-ROAD LSV6 LSV6 OFF-ROAD</p>  | <p>2.03.2271 BOX SURFACE 1 FOR REAR STORAGE BOX</p> <p>APPLY TO LSV4 LSV4 OFF-ROAD LSV6 LSV6 OFF-ROAD</p>  |
| <p>2.03.2276 INNER COVER FOR REAR STORAGE BOX</p> <p>APPLY TO LSV4 LSV4 OFF-ROAD LSV6 LSV6 OFF-ROAD</p>  | <p>2.03.2275 REAR STORAGE BOX COVER</p> <p>APPLY TO LSV4 LSV4 OFF-ROAD LSV6 LSV6 OFF-ROAD</p>  |
| <p>2.03.2278 HINGE HOLDER 2 FOR REAR STORAGE BOX</p> <p>APPLY TO LSV4 LSV4 OFF-ROAD LSV6 LSV6 OFF-ROAD</p>  | <p>2.03.2277 HINGE HOLDER FOR REAR STORAGE BOX</p> <p>APPLY TO LSV4 LSV4 OFF-ROAD LSV6 LSV6 OFF-ROAD</p>  |
| <p>2.03.2279 HINGE FOR STORAGE BOX</p> <p>APPLY TO LSV4 LSV4 OFF-ROAD LSV6 LSV6 OFF-ROAD</p>  | <p>2.03.2280 FIXED SWIVEL BASE FOR REAR STORAGE BOX</p> <p>APPLY TO LSV4 LSV4 OFF-ROAD LSV6 LSV6 OFF-ROAD</p>  |
| <p>2.03.2274 LEFT CARRY HANDLE REAR STORAGE BOX</p> <p>APPLY TO LSV4 LSV4 OFF-ROAD LSV6 LSV6 OFF-ROAD</p>  | <p>2.03.2273 RIGHT CARRY HANDLE REAR STORAGE BOX</p> <p>APPLY TO LSV4 LSV4 OFF-ROAD LSV6 LSV6 OFF-ROAD</p>  |
| <p>2.03.2272 BOX SURFACE 2 FOR REAR STORAGE BOX</p> <p>APPLY TO LSV4 LSV4 OFF-ROAD LSV6 LSV6 OFF-ROAD</p>  | <p>RIGHT CARRY HANDLE REAR STORAGE BOX</p>  |





| CANOPY PARTS | |
|--|--|
| <p>3.03.0019 CANOPY ASSEMBLY, FOUR SEATER APPLY TO LSV4 / LSV4 OFF-ROAD</p> | |
| <p>3.03.0020 CANOPY ASSEMBLY, SIX SEATER APPLY TO LSV6 / LSV6 OFF-ROAD</p> | |



| CANOPY PARTS | |
|---|--|
| <p>2.03.1589 ROOF APPLY TO LSV4 / LSV4 OFF-ROAD</p>  | <p>2.03.1590 DECORATE COVER FOR ANTENNA APPLY TO LSV4 / LSV4 OFF-ROAD</p>  |
| <p>2.01.2228 ROOF MOUNTING FRAME APPLY TO LSV4 / LSV4 OFF-ROAD</p>  | <p>2.03.1592 UPPER PROTECTIVE COVER FOR B STRUT, PASSENGER SIDE APPLY TO LSV4 / LSV4 OFF-ROAD</p>  |
| <p>2.03.1591 UPPER PROTECTIVE COVER FOR B STRUT, DRIVER SIDE APPLY TO LSV4 / LSV4 OFF-ROAD</p>  | <p>2.03.1592 UPPER PROTECTIVE COVER FOR B STRUT, PASSENGER SIDE APPLY TO LSV4 / LSV4 OFF-ROAD</p> |

| CANOPY PARTS | |
|---|--|
| <p>2.03.1173 ROOF, FRONT PART APPLY TO LSV6 / LSV6 OFF-ROAD</p>  | <p>2.03.1173 ROOF, REAR PART APPLY TO LSV6 / LSV6 OFF-ROAD</p>  |
| <p>2.01.1981 CONNECTING ROD FOR ROOF FRAME APPLY TO LSV6 / LSV6 OFF-ROAD</p>  | <p>2.01.2279 FRAME FOR ROOF, SIX SEATER APPLY TO LSV6 / LSV6 OFF-ROAD</p>  |
| <p>2.03.1271 RUBBER TAPE APPLY TO LSV6 / LSV6 OFF-ROAD</p>  | <p>2.03.2072 RUBBER TAPE APPLY TO LSV6 / LSV6 OFF-ROAD</p>  |
| <p>2.03.2131 REAR DECORATIVE STRIP FOR CANOPY SIX SEATER, DRIVER SIDE APPLY TO LSV6 / LSV6 OFF-ROAD</p> | <p>2.03.2132 REAR DECORATIVE STRIP FOR CANOPY SIX SEATER, PASSENGER SIDE APPLY TO LSV6 / LSV6 OFF-ROAD</p> |
| <p>2.03.2339 DECORATIVE BOX FOR ANTENNA APPLY TO LSV6 / LSV6 OFF-ROAD</p>  | |

| CANOPY PARTS | |
|---|--|
| <p>2.01.2082 REAR ROOF STRUT LEFT</p> <p>APPLY TO LSV4 LSV4 OFF-ROAD LSV6 LSV6 OFF-ROAD</p>  | <p>2.01.2083 REAR ROOF STRUT RIGHT</p> <p>APPLY TO LSV4 LSV4 OFF-ROAD LSV6 LSV6 OFF-ROAD</p>  |
| <p>2.03.0070 HAND HOLDER FOR ROOF</p> <p>APPLY TO LSV4 LSV4 OFF-ROAD LSV6 LSV6 OFF-ROAD</p>  | <p>2.03.2153 RECTANGULAR PIPE PLUGS</p> <p>APPLY TO LSV4 LSV4 OFF-ROAD LSV6 LSV6 OFF-ROAD</p>  |
| <p>2.01.2080 FRONT ROOF STRUT LEFT</p> <p>APPLY TO LSV4 LSV4 OFF-ROAD LSV6 LSV6 OFF-ROAD</p>  | <p>2.01.2081 FRONT ROOF STRUT RIGHT</p> <p>APPLY TO LSV4 LSV4 OFF-ROAD LSV6 LSV6 OFF-ROAD</p>  |
| <p>2.03.1593 LOWER PROTECTIVE COVER FOR A STRUT, DRIVER SIDE</p> <p>APPLY TO LSV4 LSV4 OFF-ROAD LSV6 LSV6 OFF-ROAD</p>  | <p>2.03.1594 LOWER PROTECTIVE COVER FOR A STRUT, PASSENGER SIDE</p> <p>APPLY TO LSV4 LSV4 OFF-ROAD LSV6 LSV6 OFF-ROAD</p>  |
| <p>2.03.1595 LOWER PROTECTIVE COVER FOR B STRUT, DRIVER SIDE</p> <p>APPLY TO LSV4 LSV4 OFF-ROAD LSV6 LSV6 OFF-ROAD</p>  | <p>2.03.1596 LOWER PROTECTIVE COVER FOR B STRUT, PASSENGER SIDE</p> <p>APPLY TO LSV4 LSV4 OFF-ROAD LSV6 LSV6 OFF-ROAD</p>  |





| CANOPY PARTS | |
|---|---|
| <p>2.03.2284 FIXED RUBBER FOR WINDSHIELD</p> <p>APPLY TO LSV4 LSV4 OFF-ROAD LSV6 LSV6 OFF-ROAD</p>  | <p>2.03.1327 WINDSHIELD RUBBER MAT</p> <p>APPLY TO LSV4 LSV4 OFF-ROAD LSV6 LSV6 OFF-ROAD</p>  |

| WINDSHIELD PARTS | |
|---|--|
| <p>2.05.0050 FOLDABLE ACRYLIC WINDSHIELD</p> <p>APPLY TO LSV4 LSV4 OFF-ROAD LSV6 LSV6 OFF-ROAD</p>  | <p>2.05.0050-2 FOLDABLE ACRYLIC WINDSHIELD, UPPER PART</p> <p>APPLY TO LSV4 LSV4 OFF-ROAD LSV6 LSV6 OFF-ROAD</p> |
| <p>2.05.0050-3 FOLDABLE ACRYLIC WINDSHIELD, LOWER PART</p> <p>APPLY TO LSV4 LSV4 OFF-ROAD LSV6 LSV6 OFF-ROAD</p> | <p>2.03.2176 HINGE HOLDER FOR FOLDABLE ACRYLIC WINDSHIELD, UPPER PART</p> <p>APPLY TO LSV4 LSV4 OFF-ROAD LSV6 LSV6 OFF-ROAD</p> |
| <p>2.03.2174 LEFT HINGE HOLDER FOR FOLDABLE ACRYLIC WINDSHIELD, LOWER PART</p> <p>APPLY TO LSV4 LSV4 OFF-ROAD LSV6 LSV6 OFF-ROAD</p> | <p>2.03.2175 RIGHT HINGE HOLDER FOR FOLDABLE ACRYLIC WINDSHIELD, LOWER PART</p> <p>APPLY TO LSV4 LSV4 OFF-ROAD LSV6 LSV6 OFF-ROAD</p> |
| <p>2.03.2177 FIXED PIN FOR FOLDABLE ACRYLIC WINDSHIELD HINGE</p> <p>APPLY TO LSV4 LSV4 OFF-ROAD LSV6 LSV6 OFF-ROAD</p>  | <p>2.05.0050-4 SLIDING WINDOW FOR FOLDABLE ACRYLIC WINDSHIELD</p> <p>APPLY TO LSV4 LSV4 OFF-ROAD LSV6 LSV6 OFF-ROAD</p>  |
| <p>2.01.2380 HANDLE FOR SLIDING WINDOW</p> <p>APPLY TO LSV4 LSV4 OFF-ROAD LSV6 LSV6 OFF-ROAD</p>  | <p>2.03.2341 NYLON WASHER FOR SLIDING WINDOW</p> <p>APPLY TO LSV4 LSV4 OFF-ROAD LSV6 LSV6 OFF-ROAD</p>  |

| WHINDSHIELD PARTS | |
|---|---|
| <p>2.03.2340 FIX PIN FOR RUBBER PAD</p> <p>APPLY TO LSV4 LSV4 OFF-ROAD LSV6 LSV6 OFF-ROAD</p> | <p>2.05.0050-1 RUBBER PAD FOR FOLDABLE ACRYLIC WINDSHIELD BOTTOM</p> <p>APPLY TO LSV4 LSV4 OFF-ROAD LSV6 LSV6 OFF-ROAD</p> |
| <p>2.01.2142 WINDSHIELD FIXING RUBBER SLEEVE</p> <p>APPLY TO LSV4 LSV4 OFF-ROAD LSV6 LSV6 OFF-ROAD</p>  | <p>2.03.1326 WINDSHIELD FIXING RUBBER RING</p> <p>APPLY TO LSV4 LSV4 OFF-ROAD LSV6 LSV6 OFF-ROAD</p>  |

| FRONT SEAT PARTS | |
|---|--|
| <p>2.01.2094 MIDDLE BARREL BACKREST SUPPORT</p> <p>APPLY TO LSV4 LSV4 OFF-ROAD LSV6 LSV6 OFF-ROAD</p>  | <p>2.03.1606 PLASTIC BASE COVER FOR FRONT SEAT BACK</p> <p>APPLY TO LSV4 LSV4 OFF-ROAD LSV6 LSV6 OFF-ROAD</p>  |
| <p>2.03.1610 CUP HOLDER FOR FRONT BACKREST</p> <p>APPLY TO LSV4 LSV4 OFF-ROAD LSV6 LSV6 OFF-ROAD</p>  | <p>2.03.1599 RUBBER COVER FOR SEAT</p> <p>APPLY TO LSV4 LSV4 OFF-ROAD LSV6 LSV6 OFF-ROAD</p>  |
| <p>2.03.1611 ARMREST FOR BACKREST SUPPORT</p> <p>APPLY TO LSV4 LSV4 OFF-ROAD LSV6 LSV6 OFF-ROAD</p>  | <p>2.03.1613 NETTING</p> <p>APPLY TO LSV4 LSV4 OFF-ROAD LSV6 LSV6 OFF-ROAD</p>  |
| <p>2.03.1612 NETTING POCKET DECORATIVE STRIP</p> <p>APPLY TO LSV4 LSV4 OFF-ROAD LSV6 LSV6 OFF-ROAD</p>  | <p>2.03.1601 PLASTIC BASE COVER FOR SEAT</p> <p>APPLY TO LSV4 LSV4 OFF-ROAD LSV6 LSV6 OFF-ROAD</p>  |
| <p>2.01.2214 HINGE FOR SEAT</p> <p>APPLY TO LSV4 LSV4 OFF-ROAD LSV6 LSV6 OFF-ROAD</p>  | <p>2.03.2335 BALL AND SOCKET FOR FIXED SEAT</p> <p>APPLY TO LSV4 LSV4 OFF-ROAD LSV6 LSV6 OFF-ROAD</p>  |
| <p>2.03.1254 CUSHION SNAP</p> <p>APPLY TO LSV4 LSV4 OFF-ROAD LSV6 LSV6 OFF-ROAD</p>  | <p>2.01.2317 BALL AND SOCKET FOR FIXED SEAT</p> <p>APPLY TO LSV4 LSV4 OFF-ROAD</p>  |

| SEAT PARTS | |
|--|---|
| <p>2.03.1602-2 SEAT ASSEMBLY, BLACK+WHITE</p> <p>APPLY TO LSV4 LSV4 OFF-ROAD LSV6 LSV6 OFF-ROAD</p>  | <p>2.03.1602-3 SEAT ASSEMBLY, BLACK+BLUE</p> <p>APPLY TO LSV4 LSV4 OFF-ROAD LSV6 LSV6 OFF-ROAD</p>  |
| <p>2.03.1602-1 SEAT ASSEMBLY, BLACK+RED</p> <p>APPLY TO LSV4 LSV4 OFF-ROAD LSV6 LSV6 OFF-ROAD</p>  | <p>2.03.1602 SEAT ASSEMBLY, BLACK</p> <p>APPLY TO LSV4 LSV4 OFF-ROAD LSV6 LSV6 OFF-ROAD</p>  |
| <p>2.03.1603-2 BACKREST FOR SEAT, BLACK+WHITE</p> <p>APPLY TO LSV4 LSV4 OFF-ROAD LSV6 LSV6 OFF-ROAD</p>  | <p>2.03.1603-3 BACKREST FOR SEAT, BLACK+BLUE</p> <p>APPLY TO LSV4 LSV4 OFF-ROAD LSV6 LSV6 OFF-ROAD</p>  |
| <p>2.03.1603-1 BACKREST FOR SEAT, BLACK+RED</p> <p>APPLY TO LSV4 LSV4 OFF-ROAD LSV6 LSV6 OFF-ROAD</p>  | <p>2.03.1603 BACKREST FOR SEAT, BLACK</p> <p>APPLY TO LSV4 LSV4 OFF-ROAD LSV6 LSV6 OFF-ROAD</p>  |





| REAR SEAT PARTS | |
|--|--|
| <p>2.01.2097 REAR SUPPORT FRAME</p> <p>APPLY TO LSV4 LSV4 OFF-ROAD LSV6 LSV6 OFF-ROAD</p>  | <p>2.03.1608 PLASTIC BASE COVER FOR FRONT SEAT BACK, MIDDLE</p> <p>APPLY TO LSV4 LSV4 OFF-ROAD LSV6 LSV6 OFF-ROAD</p>  |
| <p>2.03.1607 PLASTIC BASE COVER FOR FRONT SEAT BACK, LEFT</p> <p>APPLY TO LSV4 LSV4 OFF-ROAD LSV6 LSV6 OFF-ROAD</p>  | <p>2.03.1609 PLASTIC BASE COVER FOR FRONT SEAT BACK, RIGHT</p> <p>APPLY TO LSV4 LSV4 OFF-ROAD LSV6 LSV6 OFF-ROAD</p>  |



- 1** REAR SUPPORT FRAME
- 2** PLASTIC BASE COVER FOR FRONT SEAT BACK, MIDDLE
- 3** PLASTIC BASE COVER FOR FRONT SEAT BACK, LEFT
- 4** PLASTIC BASE COVER FOR FRONT SEAT BACK, RIGHT



| SEAT PARTS | |
|---|--|
| <p>2.03.2286-3 ARMREST FOR SEAT, DRIVER SIDE, BLACK+WHITE</p> <p>APPLY TO LSV4 LSV4 OFF-ROAD LSV6 LSV6 OFF-ROAD</p> | <p>2.03.2286-2 ARMREST FOR SEAT, DRIVER SIDE, BLACK+BLUE</p> <p>APPLY TO LSV4 LSV4 OFF-ROAD LSV6 LSV6 OFF-ROAD</p> |
| <p>2.03.2286-1 ARMREST FOR SEAT, DRIVER SIDE, BLACK+RED</p> <p>APPLY TO LSV4 LSV4 OFF-ROAD LSV6 LSV6 OFF-ROAD</p> | <p>2.03.2286 ARMREST FOR SEAT, DRIVER SIDE, BLACK</p> <p>APPLY TO LSV4 LSV4 OFF-ROAD LSV6 LSV6 OFF-ROAD</p> |
| <p>2.03.2287-1 ARMREST FOR SEAT, PASSENGER SIDE, BLACK+WHITE</p> <p>APPLY TO LSV4 LSV4 OFF-ROAD LSV6 LSV6 OFF-ROAD</p> | <p>2.03.2287-1 ARMREST FOR SEAT, PASSENGER SIDE, BLACK+BLUE</p> <p>APPLY TO LSV4 LSV4 OFF-ROAD LSV6 LSV6 OFF-ROAD</p> |
| <p>2.03.2287-1 ARMREST FOR SEAT, DRIVER SIDE, BLACK+RED</p> <p>APPLY TO LSV4 LSV4 OFF-ROAD LSV6 LSV6 OFF-ROAD</p> | <p>2.03.2287 ARMREST FOR SEAT, DRIVER SIDE, BLACK</p> <p>APPLY TO LSV4 LSV4 OFF-ROAD LSV6 LSV6 OFF-ROAD</p> |



| SEAT BELT PARTS | |
|---|--|
| <p>2.03.0217 THREE-POINT SEAT BELT</p> <p>APPLY TO LSV4 LSV4 OFF-ROAD LSV6 LSV6 OFF-ROAD</p>  | <p>2.03.1600 RUBBER COVER FOR SEAT BELT</p> <p>APPLY TO LSV4 LSV4 OFF-ROAD LSV6 LSV6 OFF-ROAD</p>  |

| FENDER FLARE PARTS | |
|---|--|
| <p>2.03.1582 FRONT FENDER FLARE, DRIVER SIDE</p> <p>APPLY TO LSV4 LSV4 OFF-ROAD LSV6 LSV6 OFF-ROAD</p>  <p>1</p> | <p>2.03.1584 REAR FENDER FLARE, DRIVER SIDE</p> <p>APPLY TO LSV4 LSV4 OFF-ROAD LSV6 LSV6 OFF-ROAD</p>  <p>2</p> |
| <p>2.03.1583 FRONT FENDER FLARE, PASSENGER SIDE</p> <p>APPLY TO LSV4 LSV4 OFF-ROAD LSV6 LSV6 OFF-ROAD</p>  <p>1</p> | <p>2.03.1585 REAR FENDER FLARE, PASSENGER SIDE</p> <p>APPLY TO LSV4 LSV4 OFF-ROAD LSV6 LSV6 OFF-ROAD</p>  <p>2</p> |



- 1 FRONT FENDER FLARE
- 2 REAR FENDER FLARE

| FRONT BUMPER PARTS | |
|--|---|
| <p>2.03.1543 FRONT BUMPER</p> <p>APPLY TO LSV4 LSV4 OFF-ROAD LSV6 LSV6 OFF-ROAD</p>  | <p>2.01.2229 MOUNTING BRACKET FOR FRONT BUMPER</p> <p>APPLY TO LSV4 LSV4 OFF-ROAD LSV6 LSV6 OFF-ROAD</p>  |
| <p>FRONT BRUSH GUARD</p> <p>APPLY TO LSV6 LSV6 OFF-ROAD</p>  | |









| GOLF BAG HOLDER PARTS | |
|---|--|
| <p>2.01.2245 GOLF BAG HOLDER WITHOUT BELT</p> <p>APPLY TO LSV4 LSV4 OFF-ROAD LSV6 LSV6 OFF-ROAD</p>  <p>1</p> | <p>2.03.0060 GOLF BAG BELT HOLD DOWN CLAMPS</p> <p>APPLY TO LSV4 LSV4 OFF-ROAD LSV6 LSV6 OFF-ROAD</p>  <p>3</p> |
| <p>2.03.0059 GOLF BAG SUPPORT BELT</p> <p>APPLY TO LSV4 LSV4 OFF-ROAD LSV6 LSV6 OFF-ROAD</p>  <p>2</p> | |















- 1 GOLF BAG HOLDER WITHOUT BELT
- 2 GOLF BAG BELT HOLD DOWN CLAMPS
- 3 GOLF BAG SUPPORT BELT

| MANUAL & WARNING DECAL PARTS | |
|---|--|
| <p>2.04.1415 LOGO STICKER FOR LiFePO4 BATTERY, DRIVER SIDE</p> <p>APPLY TO LSV4 LSV4 OFF-ROAD LSV6 LSV6 OFF-ROAD</p>  | <p>2.04.1416 LOGO STICKER FOR LiFePO4 BATTERY, PASSENGER SIDE</p> <p>APPLY TO LSV4 LSV4 OFF-ROAD LSV6 LSV6 OFF-ROAD</p>  |
| <p>2.07.0610 OPERATOR WARNING DECAL</p> <p>APPLY TO LSV4 LSV4 OFF-ROAD LSV6 LSV6 OFF-ROAD</p>  | <p>HEAVY WARNING DECAL</p> <p>APPLY TO LSV4 LSV4 OFF-ROAD LSV6 LSV6 OFF-ROAD</p>  |
| <p>REAR SEAT OCCUPANT WARNING DECAL</p> <p>APPLY TO LSV4 LSV4 OFF-ROAD LSV6 LSV6 OFF-ROAD</p>  | <p>2.07.0567 OPERATION INSTRUCTION DECAL</p> <p>APPLY TO LSV4 LSV4 OFF-ROAD LSV6 LSV6 OFF-ROAD</p>  |
| <p>2.07.0691 OWNER'S MANUAL, DEL3045G</p> <p>APPLY TO LSV4</p>  | |

| FRONT BUMPER PARTS | | |
|--|--|---|
| <p>1.01.0005 HEX HEAD NUT, M5</p>  | <p>1.01.0009 HEX HEAD NUT, M8</p>  | <p>1.03.0067 HEX HEAD ANTI-LOOSE NUT, M5</p>  |
| <p>1.03.0011 HEX HEAD ANTI-LOOSE NUT, M10</p>  | <p>1.01.0027 HEX HEAD ANTI-LOOSE NUT, M8</p>  | <p>1.01.0030 HEX HEAD ANTI-LOOSE NUT, M6</p>  |
| <p>1.01.0018 HEX HEAD ANTI-LOOSE NUT, M5</p>  | <p>2.01.0137 B TYPE SPRING NUT, M6, 11x19</p>  | <p>2.01.0138 A TYPE SPRING NUT, ST4.8LP016/11x17</p>  |
| <p>1.03.0007 EXTRA LARGE WASHER, φ10</p>  | <p>1.01.0028 EXTRA LARGE WASHER, φ6</p>  | <p>1.01.0010 EXTRA LARGE WASHER, φ5</p>  |
| <p>1.01.0041 WASHER, φ6</p>  | <p>1.01.0007 WASHER, φ8</p>  | <p>1.01.0046 WASHER, φ10</p>  |
| <p>1.01.0157 WASHER, φ12</p>  | <p>1.01.0004 SNAP WASHER, φ5</p>  | <p>1.01.0042 SNAP WASHER, φ6</p>  |
| <p>1.01.0008 SNAP WASHER, φ8</p>  | <p>1.01.0060 SNAP WASHER, φ10</p>  | <p>1.08.0010 RIVET, 4.8x18x16</p>  |
| <p>1.01.0076 HEX HEAD BOLT, M5x20</p>  | <p>1.01.0081 HEX HEAD BOLT, M6x30</p>  | <p>1.03.0022 HEX HEAD BOLT, M8x25</p>  |

| FENDER FLARE PARTS | | |
|---|--|--|
| 1.03.0017 HEX HEAD BOLT, M8×30  | 1.03.0094 HEX HEAD BOLT, M8×40  | 1.03.0014 HEX HEAD BOLT, M8×45  |
| 1.03.0053 HEX HEAD BOLT, M10×45  | 1.03.0032 HEX HEAD BOLT, M10×80  | 1.03.0055 HEX HEAD NUT, M10×100  |
| 1.03.0091 HEX HEAD BOLT, M12×60  | 1.03.0086 HEX HEAD NUT, M12×85  | 1.03.0081 HEX HEAD NUT, M12×100  |
| 1.03.0071 HEX HEAD BOLT, M12×120  | 1.02.0068 HEX HEAD BOLT, M6×16  | 1.01.0023 HEX HEAD BOLT, M6×25  |
| 1.03.0019 HEX HEAD BOLT, M6×30  | 1.01.0025 HEX HEAD BOLT, M8×45  | 1.01.0086 HEX HEAD BOLT, M8×60  |
| 1.03.0026 HEXAGON SOCKET HEAE CAP SCREWS, M10×45  | 1.01.0237 HEXAGON SOCKET HEAE CAP SCREWS, M5×30  | 1.01.0184 HEXAGON SOCKET HEAE CAP SCREWS, M6×45  |
| 1.01.0183 HEXAGON SOCKET HEAE CAP SCREWS, M6×60  | 1.01.0182 HEXAGON SOCKET HEAE CAP SCREWS, M8×25  | 1.01.0194 HEXAGON SOCKET HEAE CAP SCREWS, M6×45  |
| 1.02.0042 PAN HEAD SCREW, M6×30  | 1.01.0076 PAN HEAD SCREW, M5×20  | 1.01.0029 PAN HEAD SCREW, M6×25  |

| FRONT BUMPER PARTS | | |
|---|---|---|
| 1.01.0081 PAN HEAD SCREW, M6×30  | 1.01.0062 PAN HEAD SCREW, M6×40  | 1.01.0083 PAN HEAD SCREW, M6×45  |
| 1.01.0248 PAN HEAD SCREW, M6×50  | 1.01.0055 PAN HEAD SCREW, M6×65  | 1.02.0077 PAN HEAD SCREW, ST4.8×16  |
| 1.02.0080 PAN HEAD SCREW, ST4.8×25  | 1.02.0013 PAN HEAD SCREW, ST3.9×25  | 1.02.0038 PAN HEAD SCREW, M6×15  |
| PAN HEAD SCREW, M6×20  | 1.02.0002 PAN HEAD SCREW, ST4.8×16  | 1.01.0270 PAN HEAD SCREW, ST4.8×25  |
| 1.08.0061 M12  | | |

